

REVISION RECORD					
REV	ECO	DESCRIPTION	DATE	DRFT	APVD
01	N/A	INITIAL RELEASE FOR REVIEW	02/26/08	SJL	

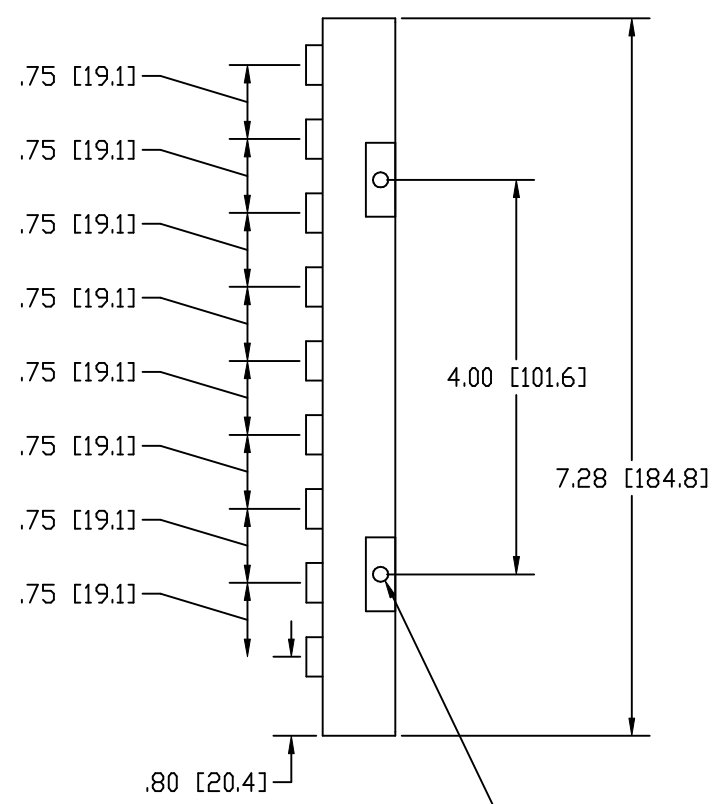

4-40 THREADED HOLE
MAX SCREW LENGTH .25 [6.3]
(6 PLACES)

MINI MOUNTING CLIP DIMENSIONS (NOT TO SCALE)

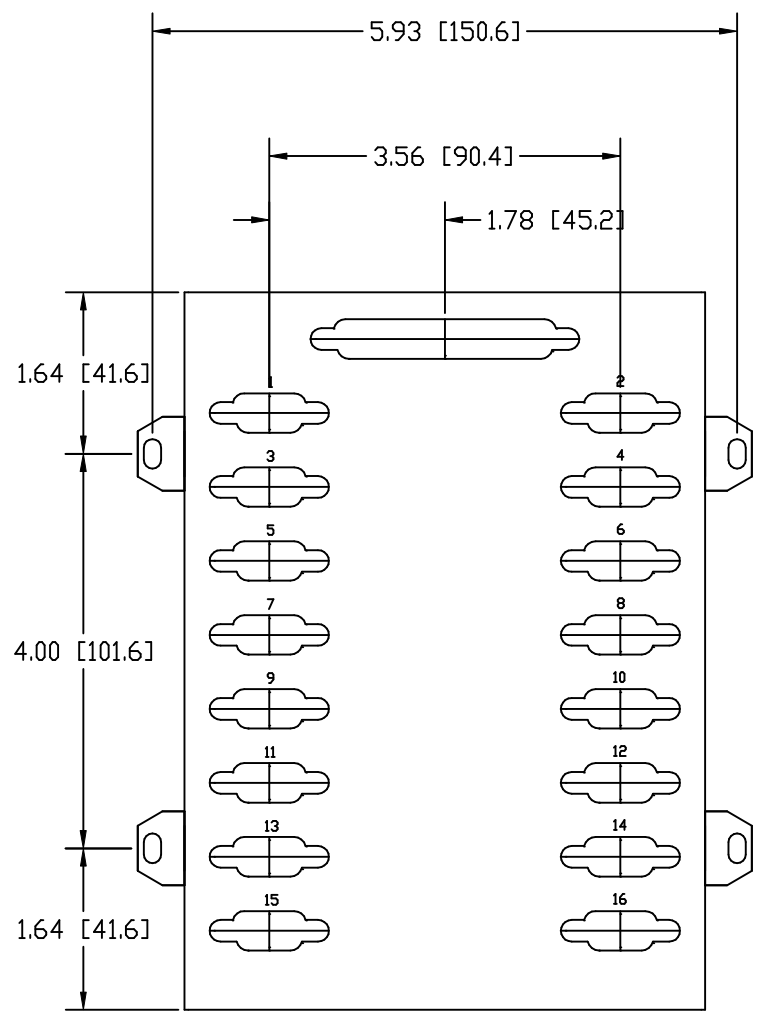
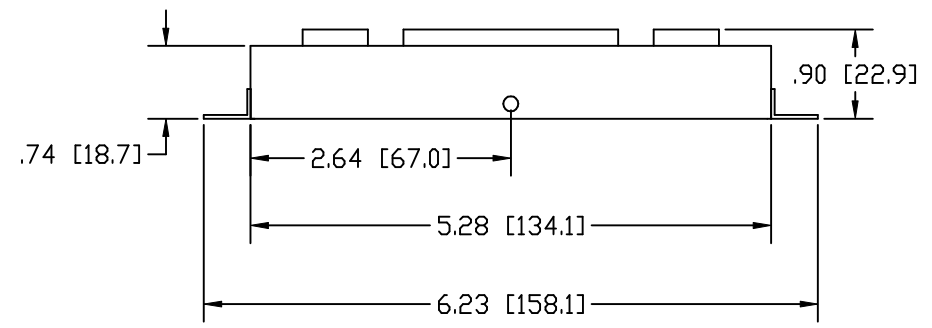
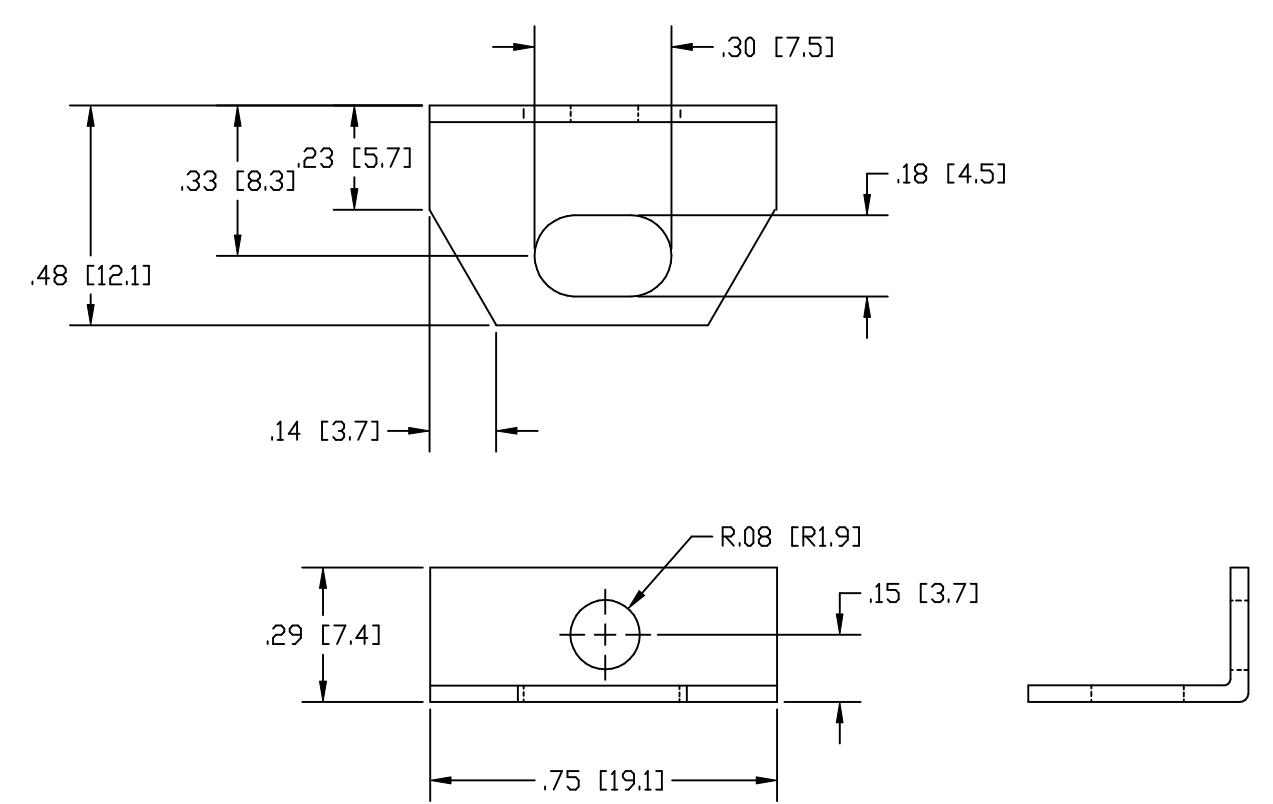

DIMENSIONS ARE IN INCHES [MM]				
CONTROL CORP.				
TITLE ROCKETPORT INTERFACE, DB9, RS-232/422/485, 16-PORT 30030-4, 30035-9				
FILENAME RP_IFC_DB9_16P_01.DWG				
SIZE B	BY SJL	DATE 02/26/08	REV 01	SHEET 1 OF 1